

BWOO[®]
TRUE WIRELESS
STEREO
BW67

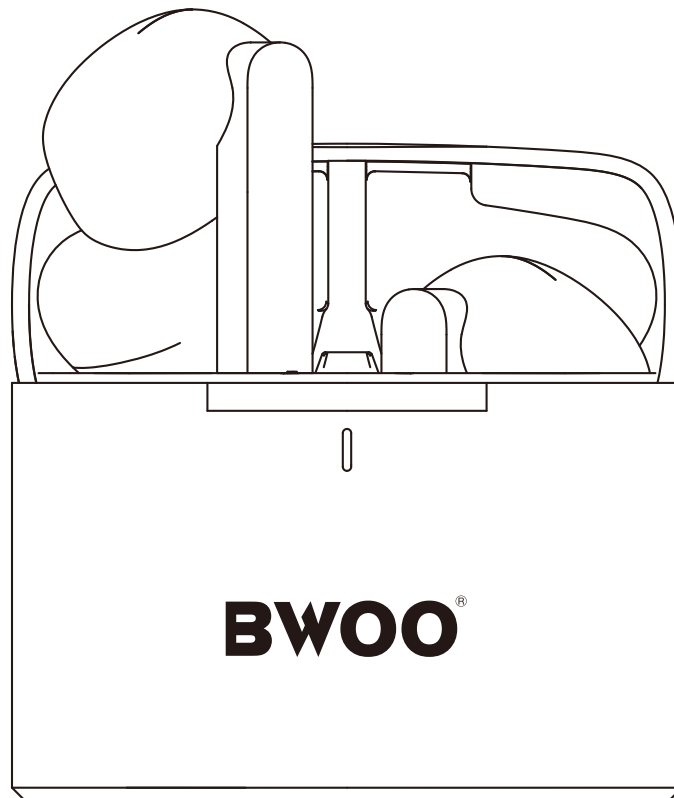

1. Power On, Pairing, And Connecting To Device

A. Automatic ON when BW67 is taken out of charging case

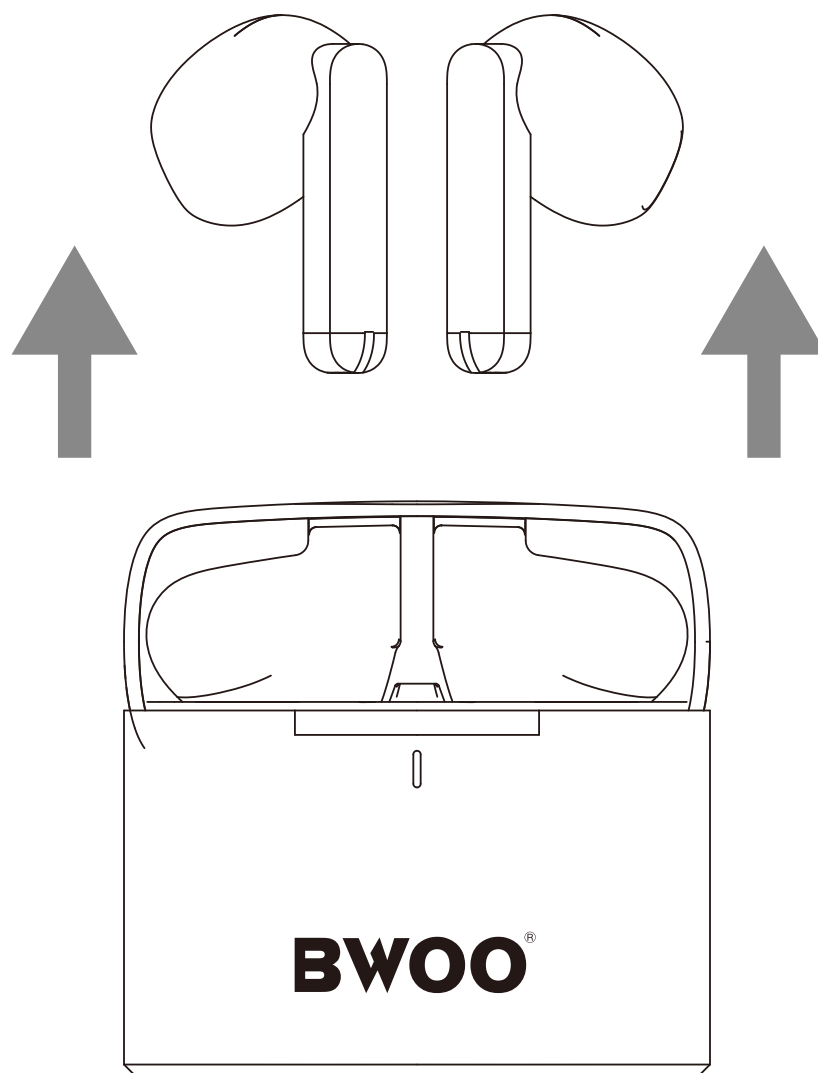

B. Tunebuds will automatically enter pairing mode. Turn on bluetooth on the mobile phone, click search for the device Choose “BW67” to connect.

Note: When BW67 and mobile phone are disconnected due to distance, Tunebuds will automatically attempt to reconnect for 3 minutes

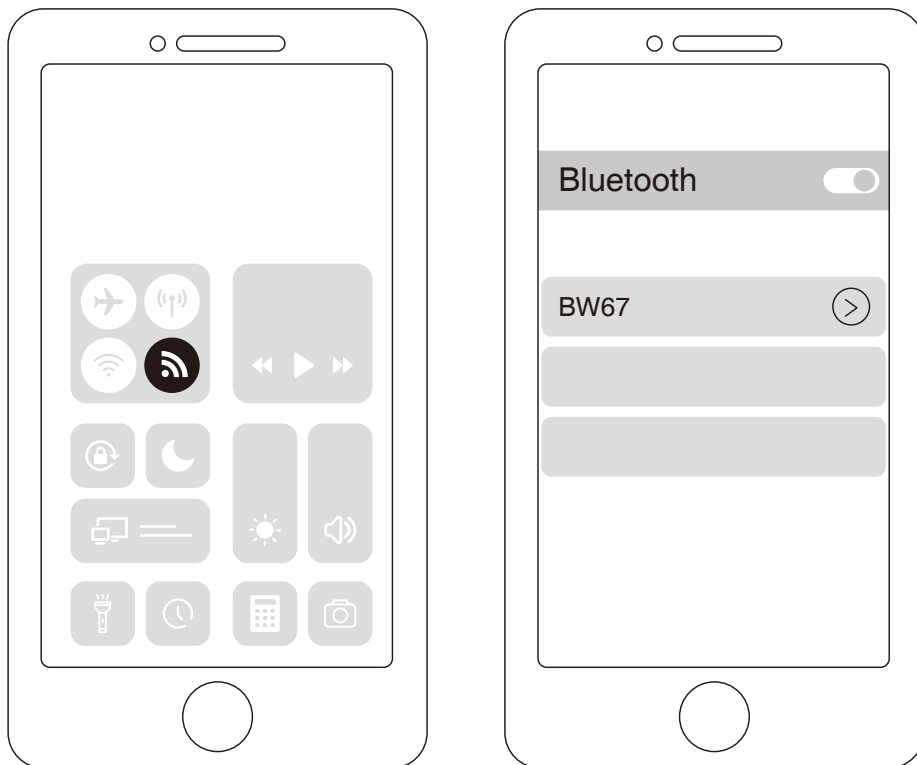

C. Or put it back in the charging case and close the lid.

Tunebuds will automatically shut down and enter the charging mode.

Tunebuds will automatically turn-off if:

·there is no connection in 5 minutes, or when the battery voltage drops to 3V

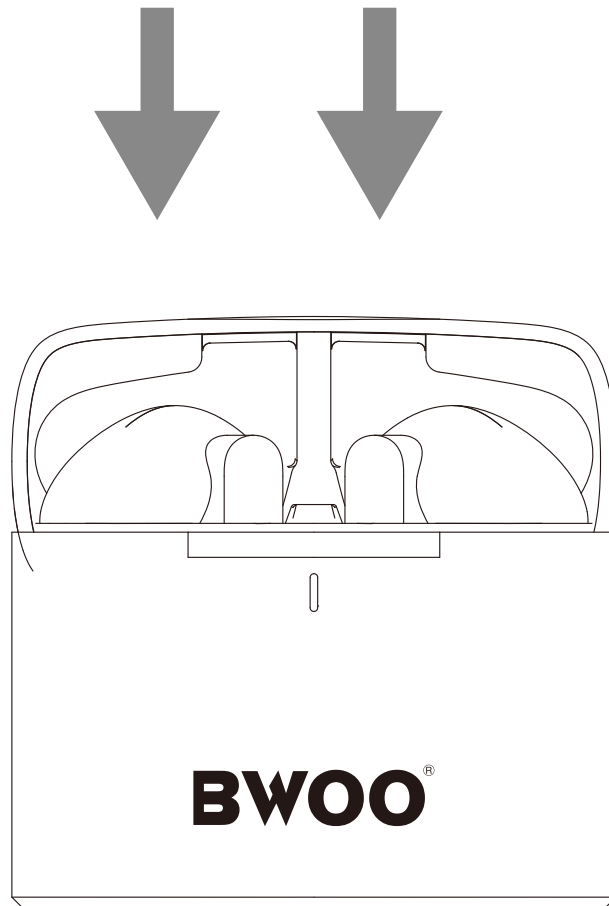

INSERT EARPHONES

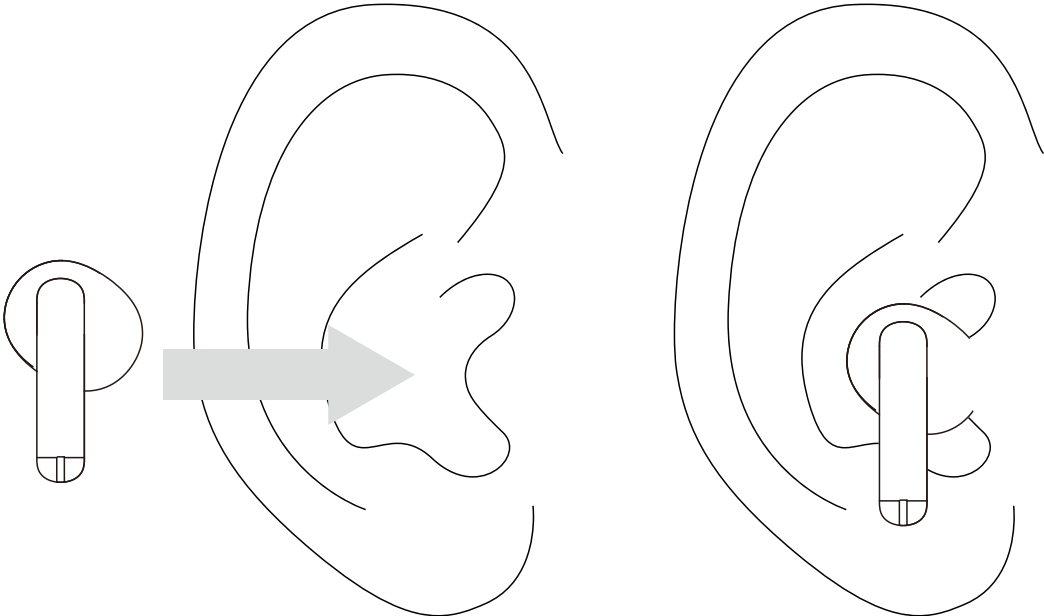

MUSIC OPERATIONS

L

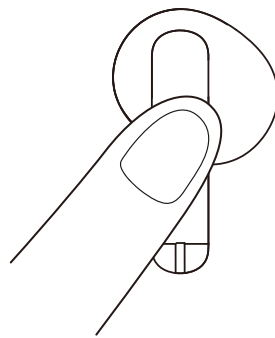

R

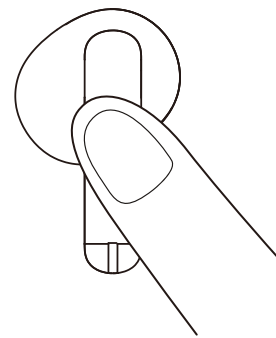

▷ Play/Pause		●● Double press
> Next		●●● Three press
< Previous	●●● Three press	
+ Volume		●●●● Four press
- Volume	●●●● Four press	
Call voice assistant	●● Double press	

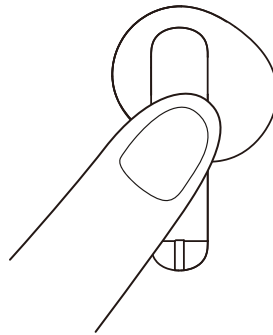

CALL OPERATIONS

L

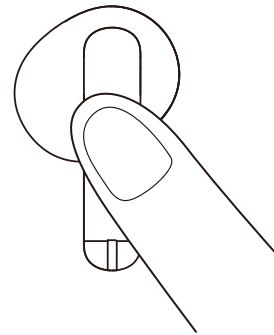

R



 Incoming call	● ● Double press	● ● Double press
 End call	● ● Double press	● ● Double press
Call rejection	● ● ● Three press	● ● ● Three press

CHARGING

Note: Please use the original charger wire to charge the headset. Do not use fast charging to avoid damage or reduce the service life of the headset.

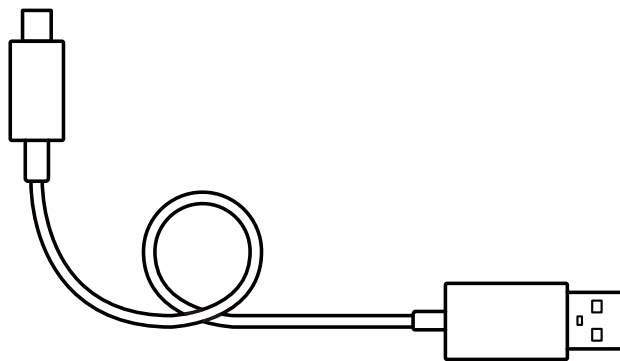
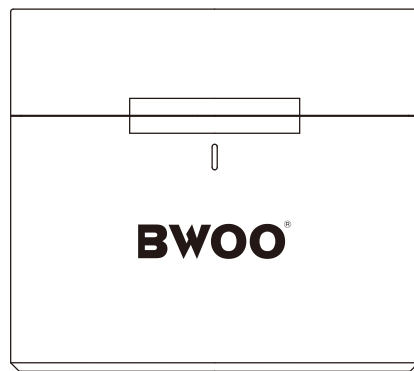

BOX OVERVIEW

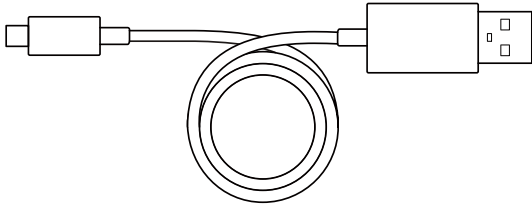
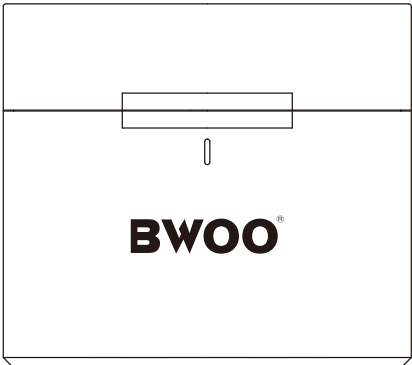
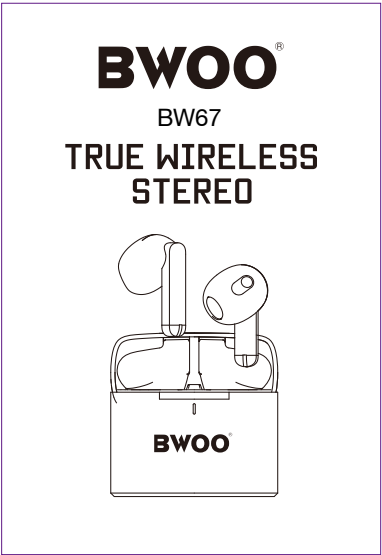
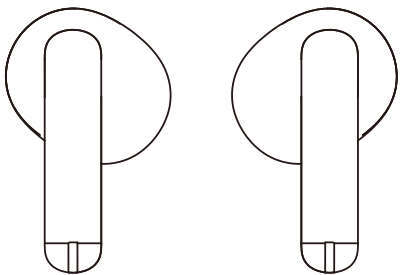

BWOO[®]

<https://bwoohk.com>