

**BWOO<sup>®</sup>**  
**TRUE WIRELESS**  
**STEREO**  
BW66

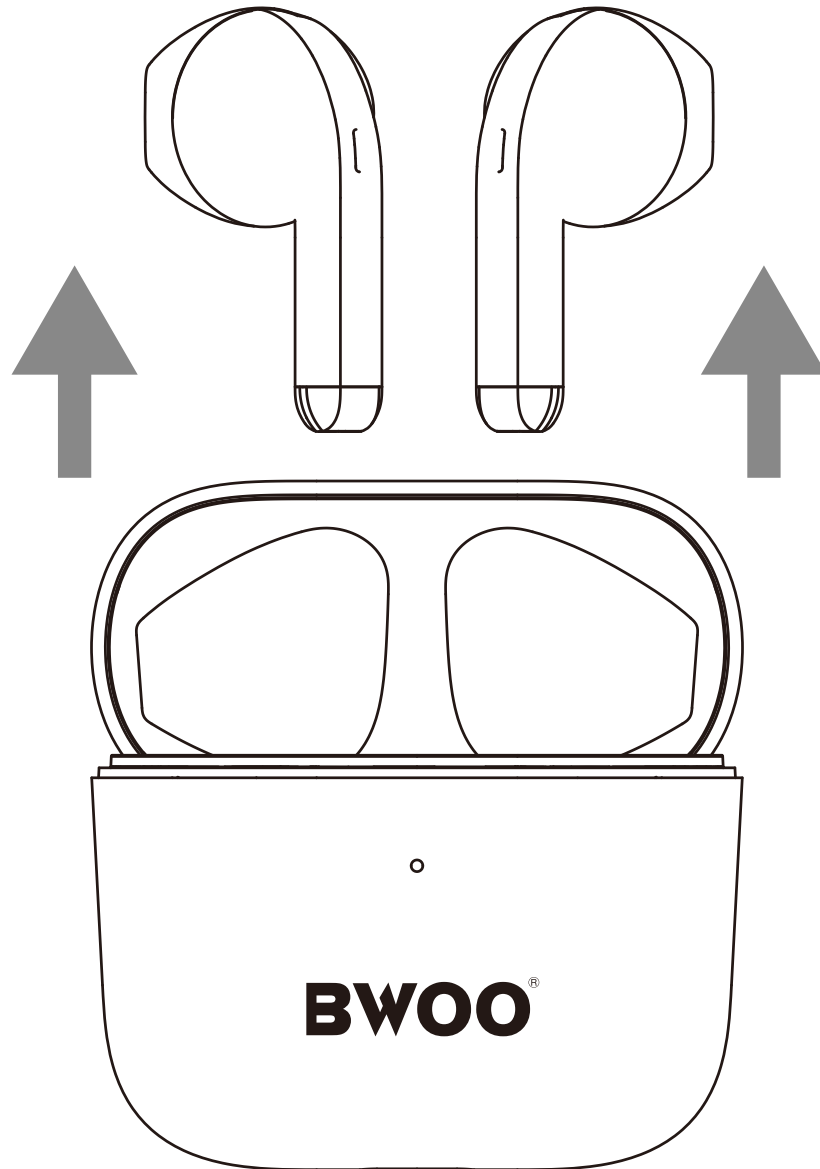

# 1. Power On, Pairing, And Connecting To Device

A. Automatic ON when BW66 is taken out of charging case



**B. Tunebuds will automatically enter pairing mode. Turn on bluetooth on the mobile phone, click search for the device Choose “BW66” to connect.**

*Note: When BW66 and mobile phone are disconnected due to distance, Tunebuds will automatically attempt to reconnect for 3 minutes*

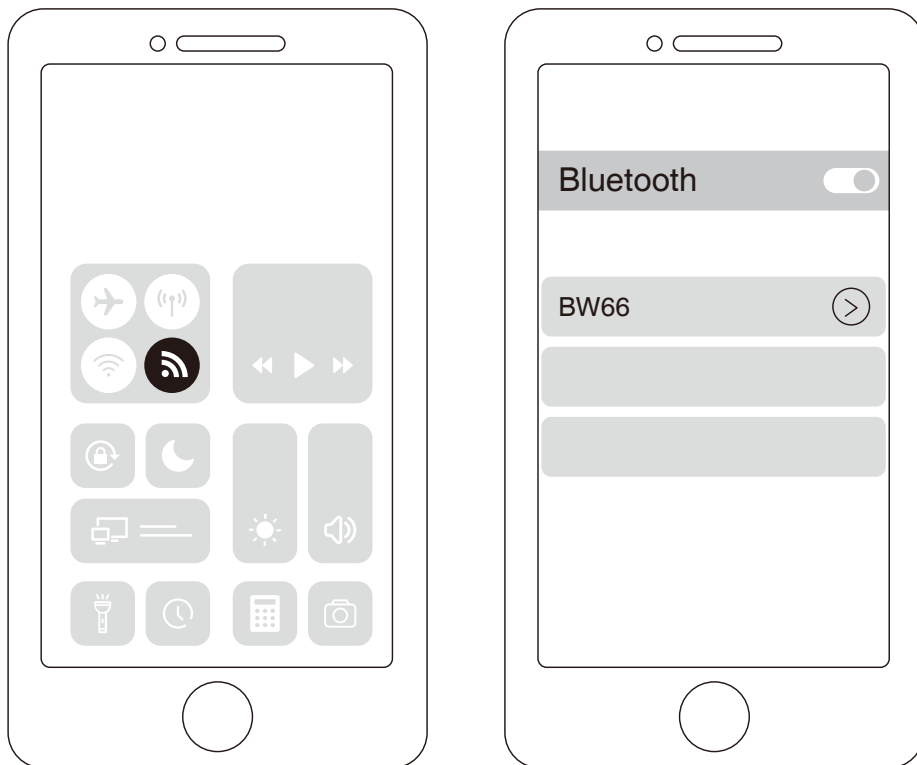

**C. Or put it back in the charging case and close the lid.**

**Tunebuds will automatically shut down and enter the charging mode.**

**Tunebuds will automatically turn-off if:**

*·there is no connection in 5 minutes, or when the battery voltage drops to 3V*

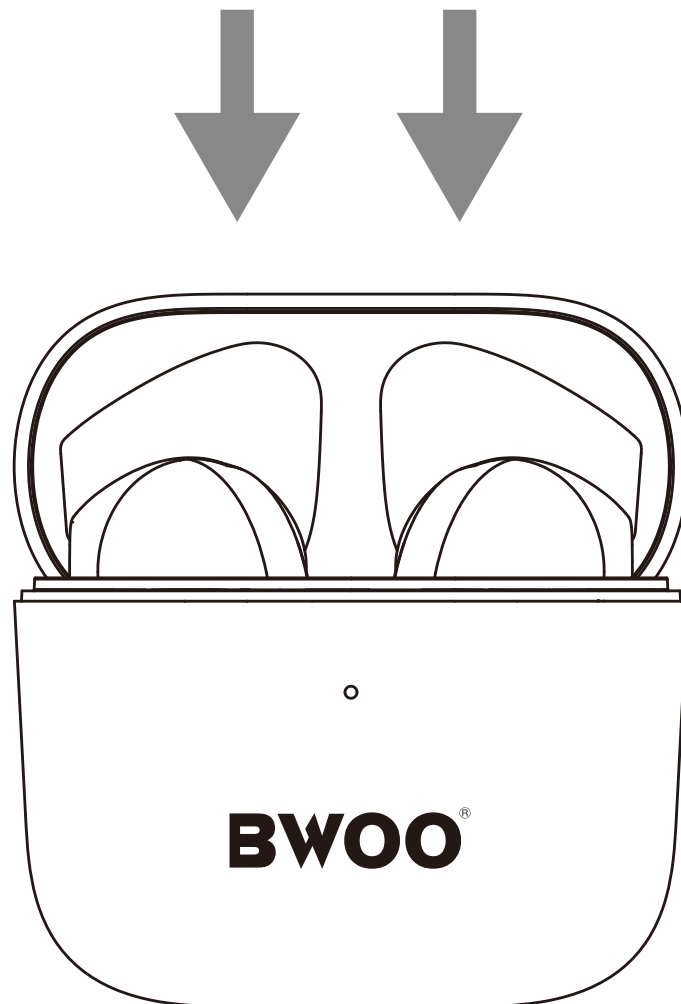

# INSERT EARPHONES

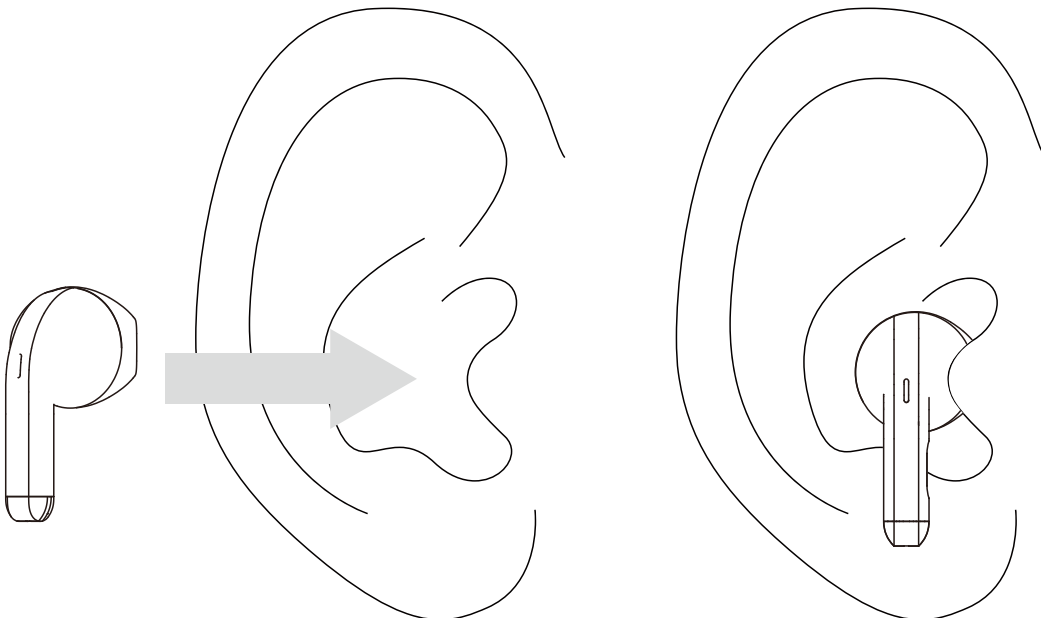

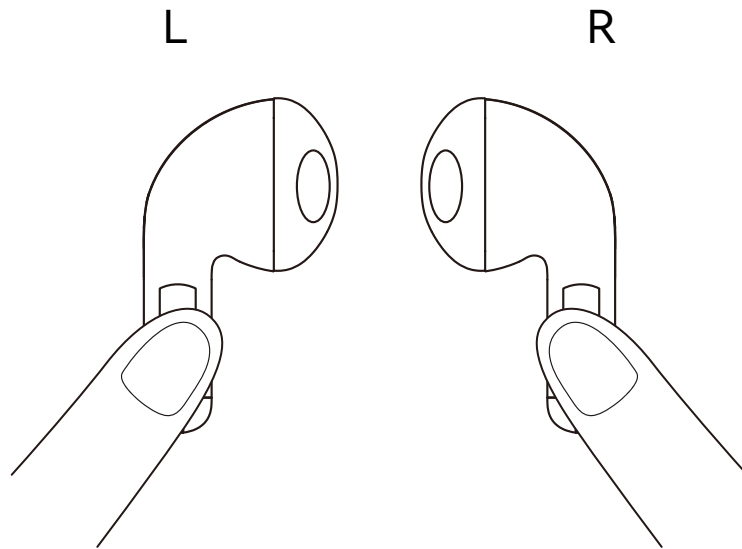

# MUSIC OPERATIONS

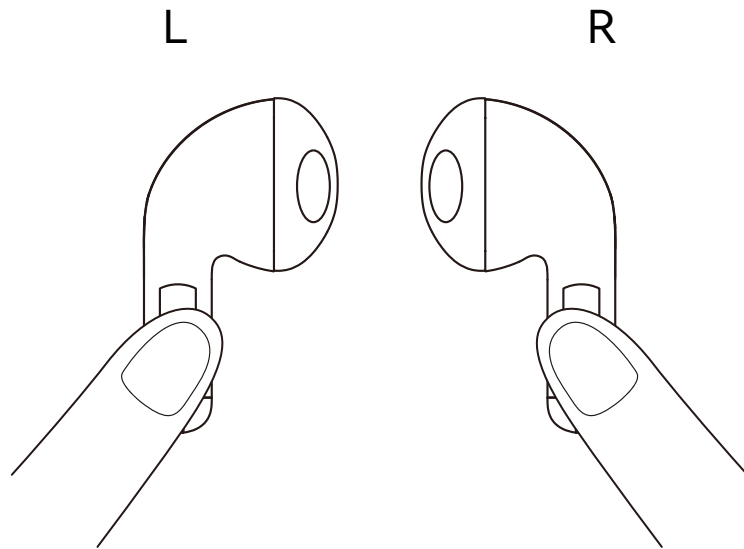

▶   Play/Pause	● Single press	● Single press
> Next		●● Double press
< Previous	●● Double press	
+ Volume	▬ Hold	
- Volume		▬ Hold

# CALL OPERATIONS



 <b>Incoming call</b>	● Single press	● Single press
 <b>End call</b>	● Single press	● Single press
<b>Call rejection</b>	▬ Hold	▬ Hold

## CHARGING

*Note: Please use the original charger wire to charge the headset. Do not use fast charging to avoid damage or reduce the service life of the headset.*

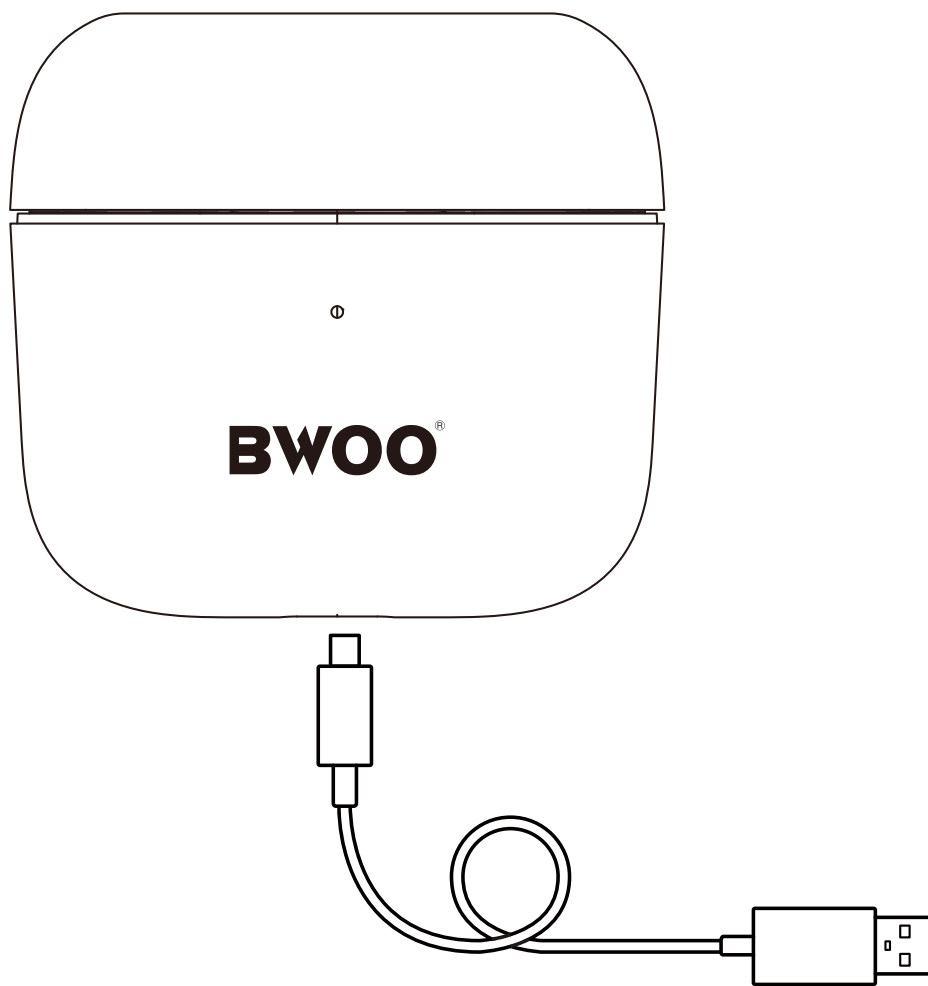



# BOX OVERVIEW

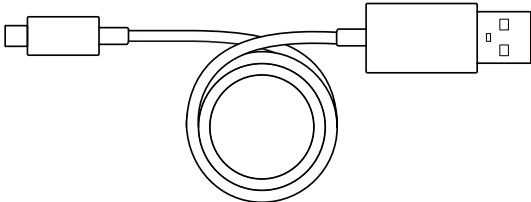
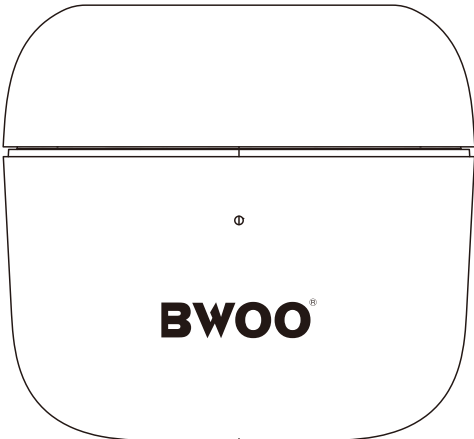
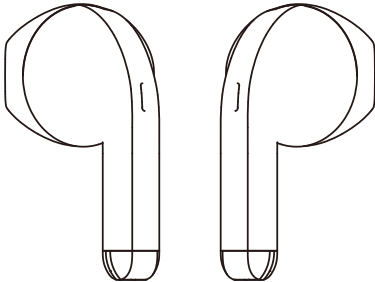

**BWOO<sup>®</sup>**

<https://bwoohk.com>